

RUHR-UNIVERSITÄT BOCHUM

Transcriptome-wide Structure Probing with Lead-Seq

Vivian Brandenburg
 35th TBI Winterseminar in Bled
 12/02/20

RNA Structure Probing

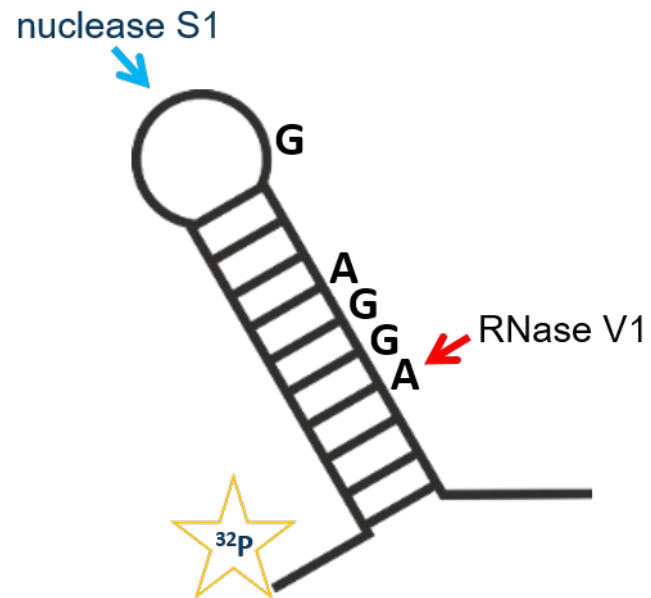

S1 → cuts single-stranded nt
V1 → cuts double-stranded nt

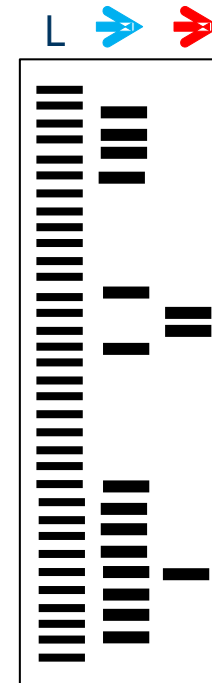

Polyacrylamide urea gel
→ separation of fragments by size
→ detection via radioactive P-32

Ehresmann *et al.*, 1987

Global RNA Structure Probing

- Structure Probing + NGS
- **Structurome** = Structure of all RNAs in a cell
- *In vitro*: enzymes
- *In vivo*: chemical agents

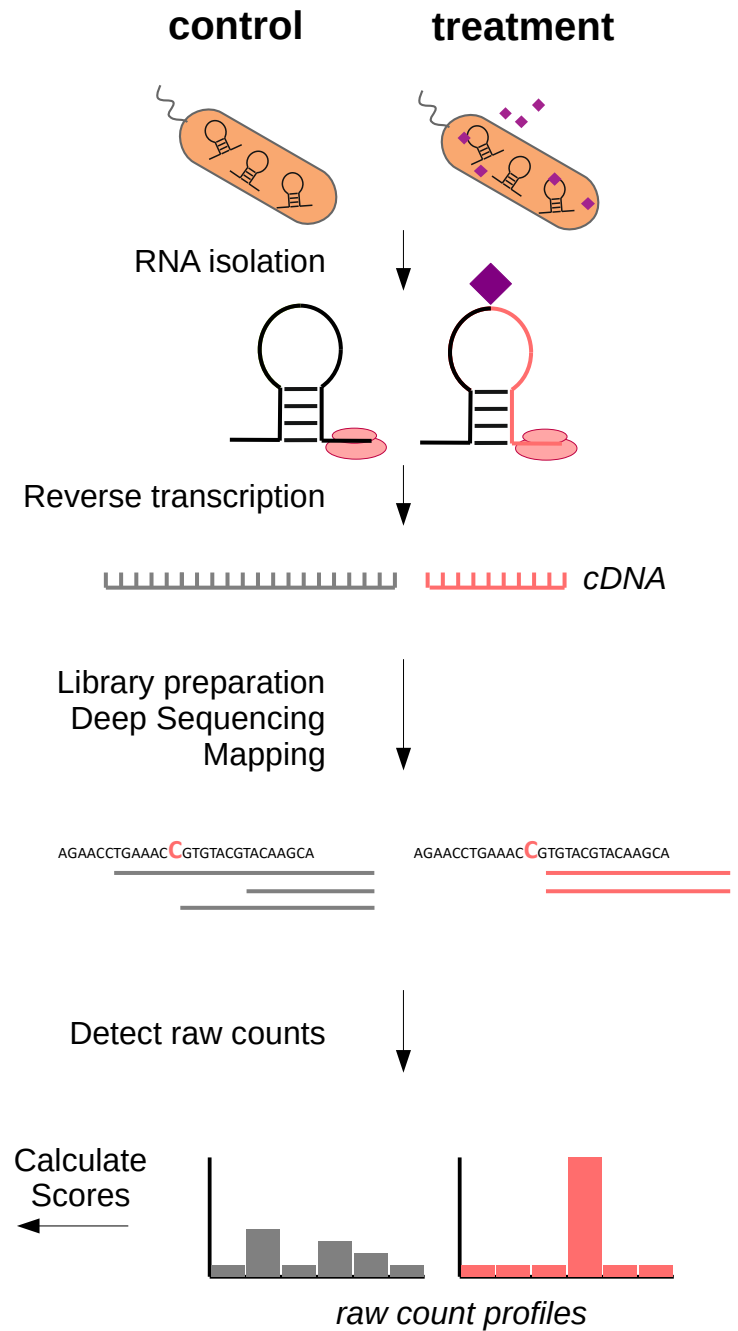

Chemical Agents for *in vivo* probing

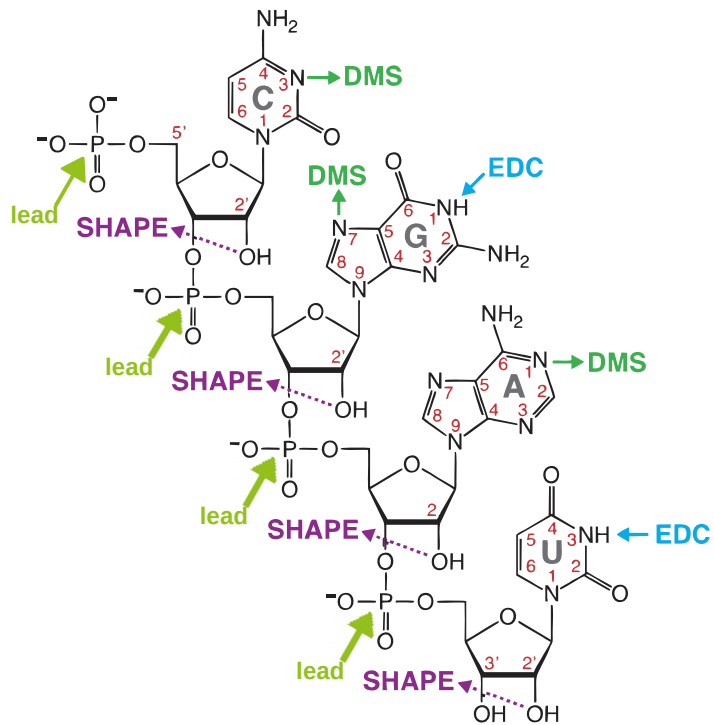

Adapted from Mitchell *et al.*, 2019

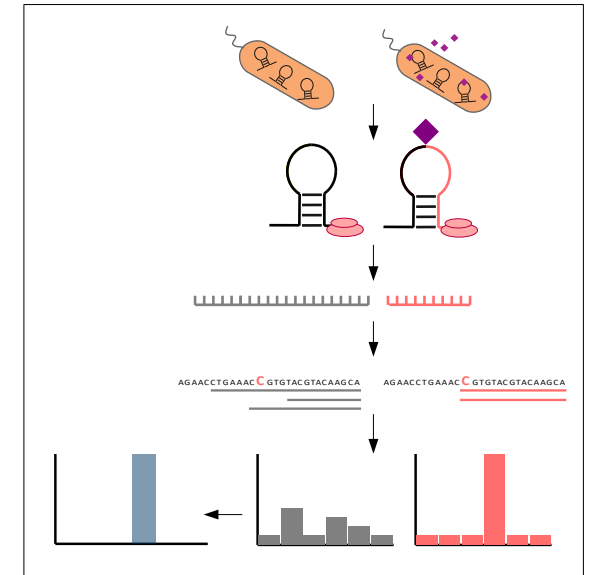

- DMS: alkylation of Watson-Crick-face of A and C
→ can be combined with e.g. EDC
- SHAPE: 2'-OH acylation of ribose sugar
- Lead: nucleophilic attack of phosphorus group

Y. pseudotuberculosis



- Gram-negative γ -proteobacterium
- Closely related to *Y. pestis* / plague
- Mammalian pathogen
- Gut-associated diseases

Extensive regulatory response to temp. changes

- > 300 genes differentially expressed
(Nuss *et al.*, 2015)
- virulence, metabolism, diverse stress response

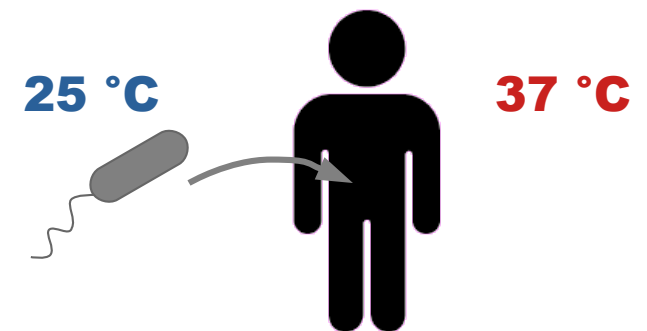

Lead-Seq at 25 °C and 37 °C

Reliability of Lead Scores: tRNAs

Test data: 32 tRNAs (764 paired + 665 unpaired nt)

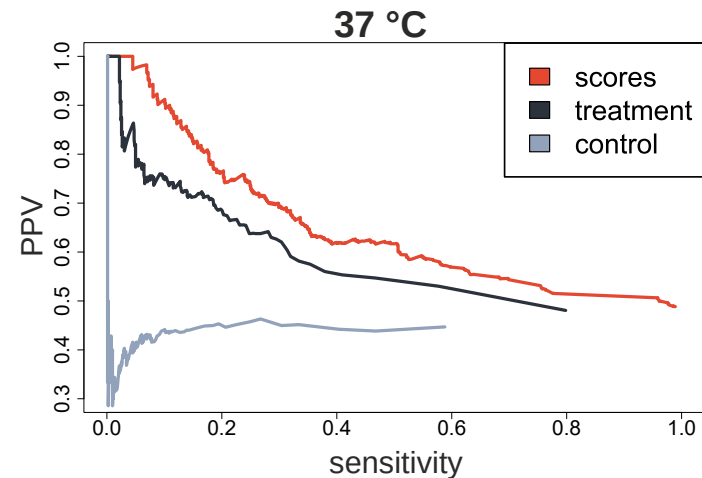
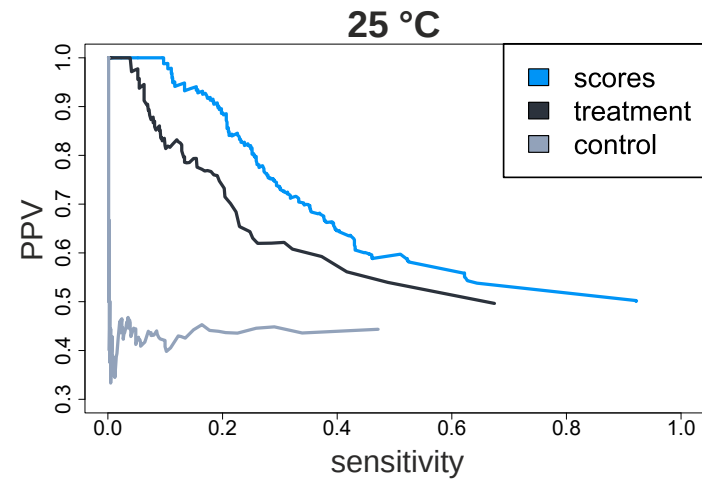
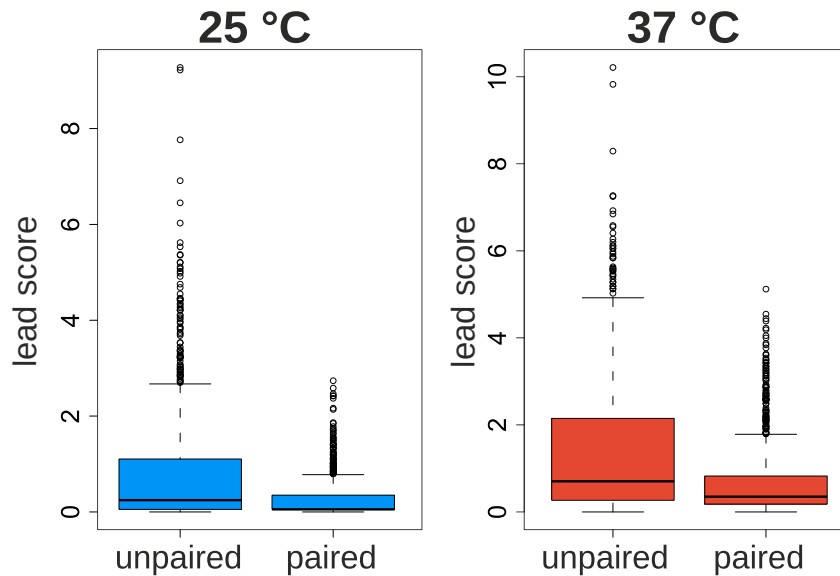

PPV: How many of the nt with scores are actually unpaired?

Sensitivity: how many of all unpaired nt can we detect?

Reliability of Lead Scores: 16S-rRNA

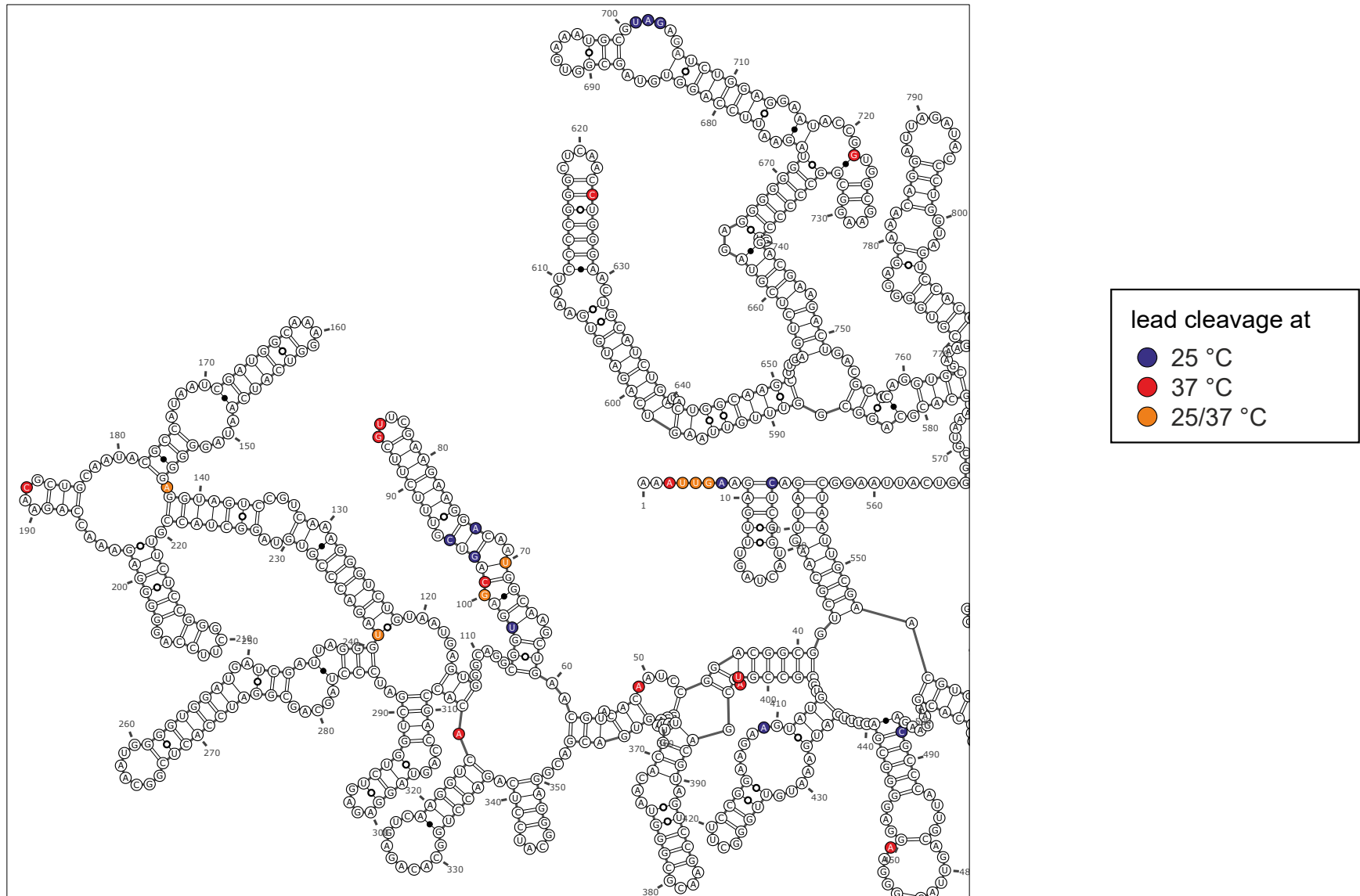

Reliability of Lead Scores: 16S-rRNA

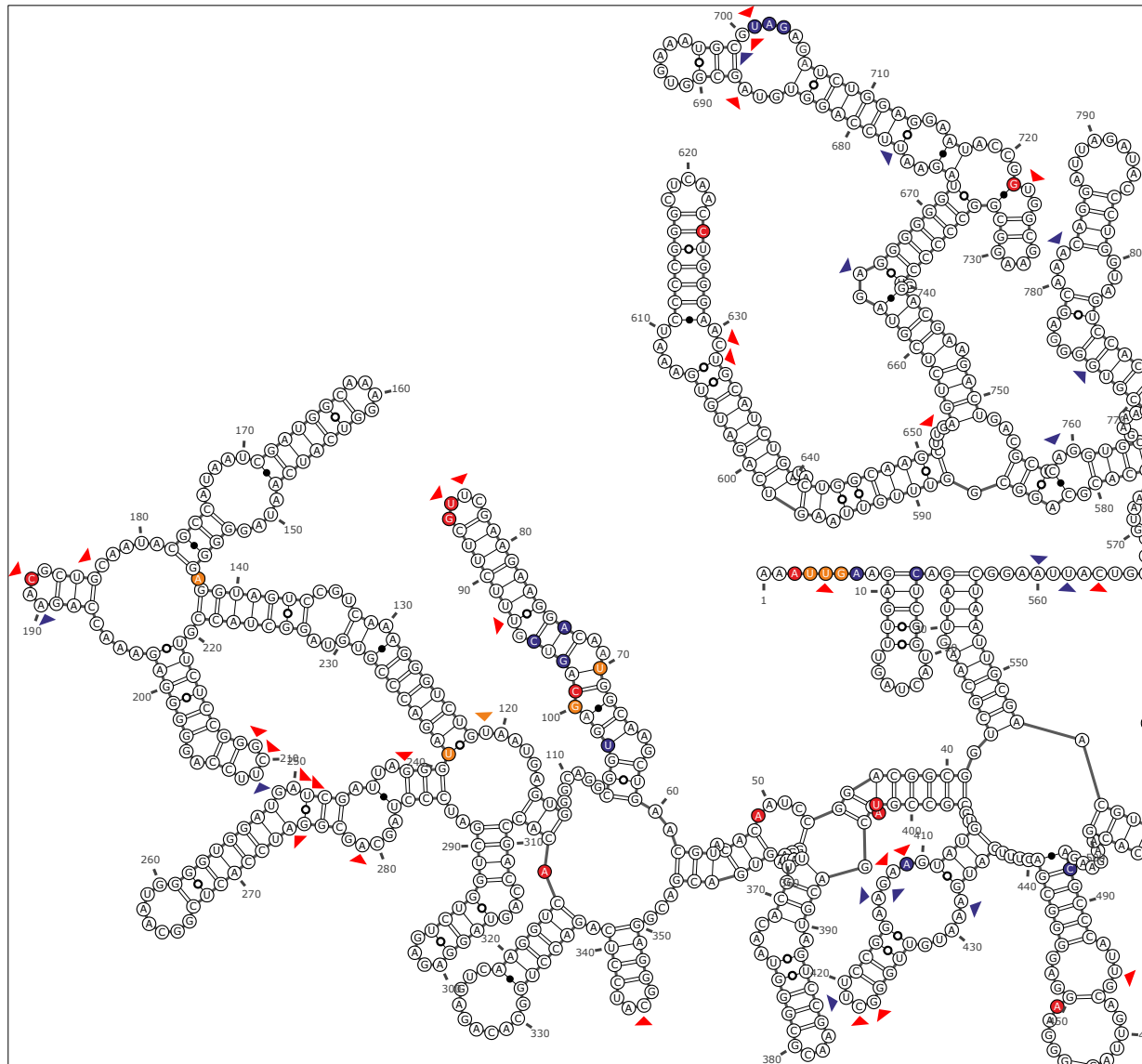

lead cleavage at

- 25 °C
- 37 °C
- 25/37 °C

strong reactivity

- ▶ DMS
Mustoe *et al.*, 2019
- ▶ SHAPE
McGinnis *et al.*, 2015

Secondary Structure Prediction

Problem: No information about pairing partners

Solution: RNA structure prediction with soft constraints with ViennaRNA 2.0
approach from Washietl *et al.*, 2012 (RNApvm: tauSigmaRatio=0.6)

Test data: 32 tRNAs

Pre-processing:

- cap at 90 %
- rescale to range 0, 2
- exclude all < 1

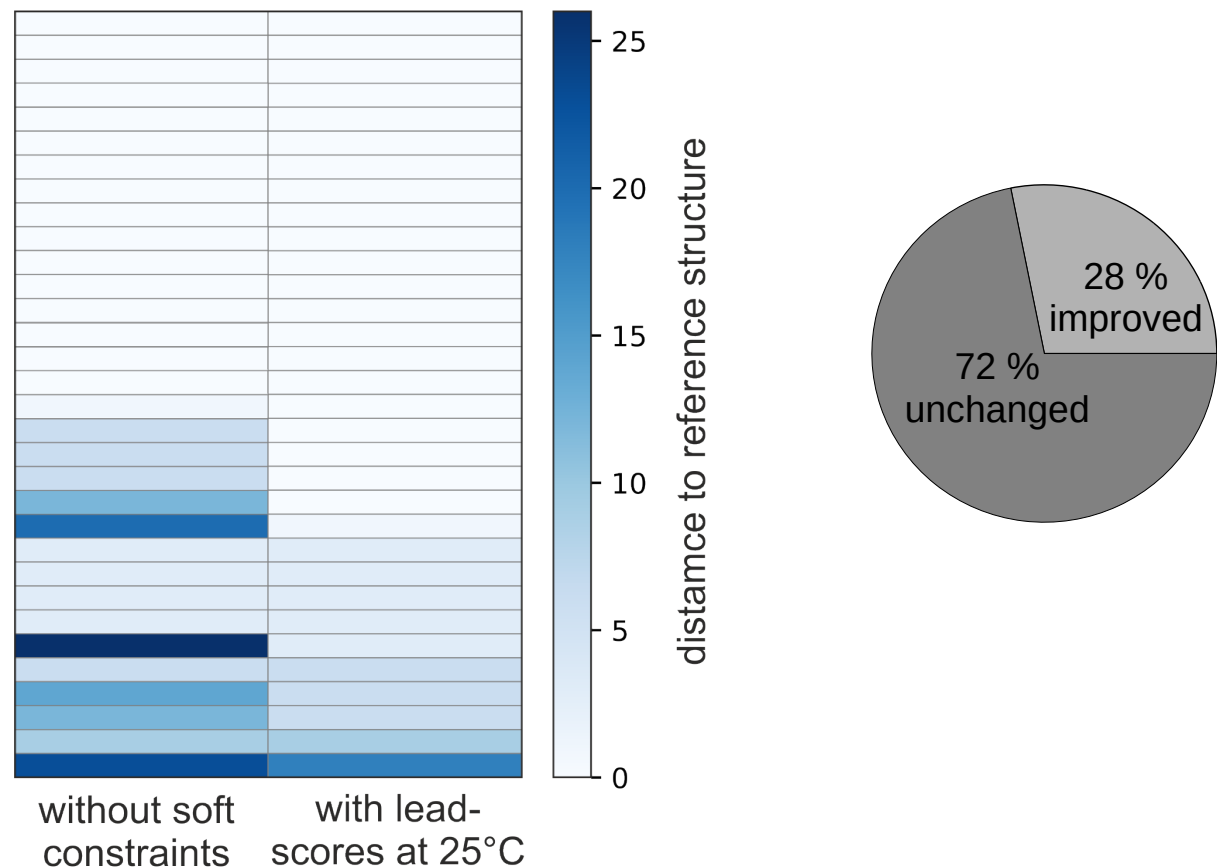

Temp. comparisons

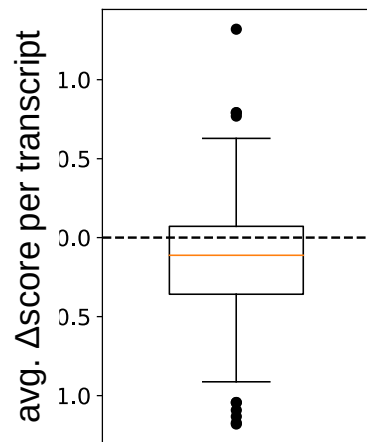
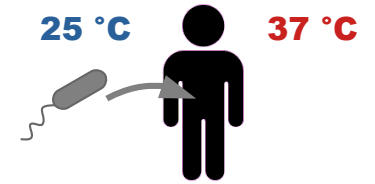

25 °C

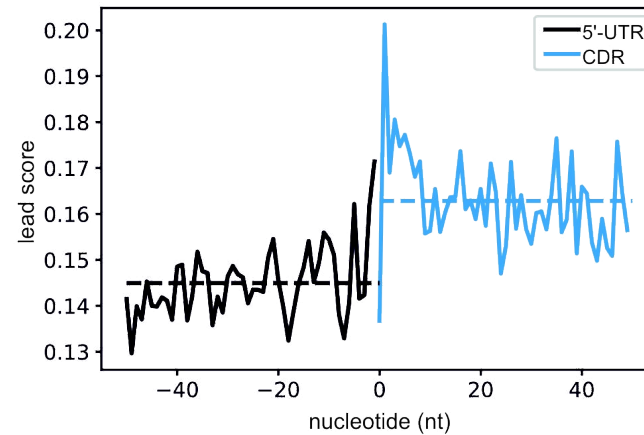

37 °C

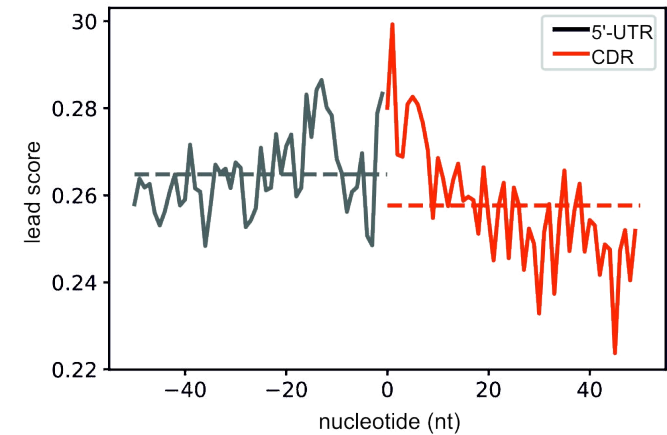

Same results: HIV-1 virions, Fruit flies, humans

Different: Arabidopsis th., rice, yeast

Same result: rice

RNA Thermometers

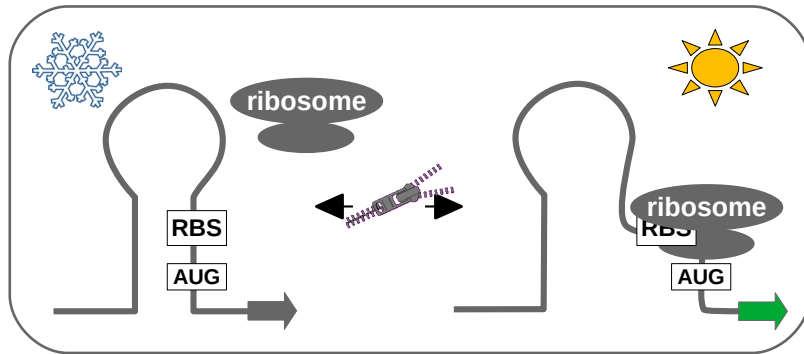
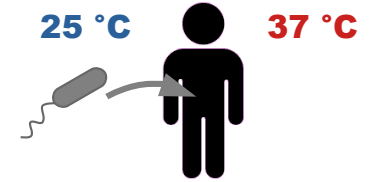

- Diverse examples in bact. pathogens
- *Yersinia pseudotuberculosis*
 - LcrF: major virulence regulator (Böhme *et al.*, 2012)

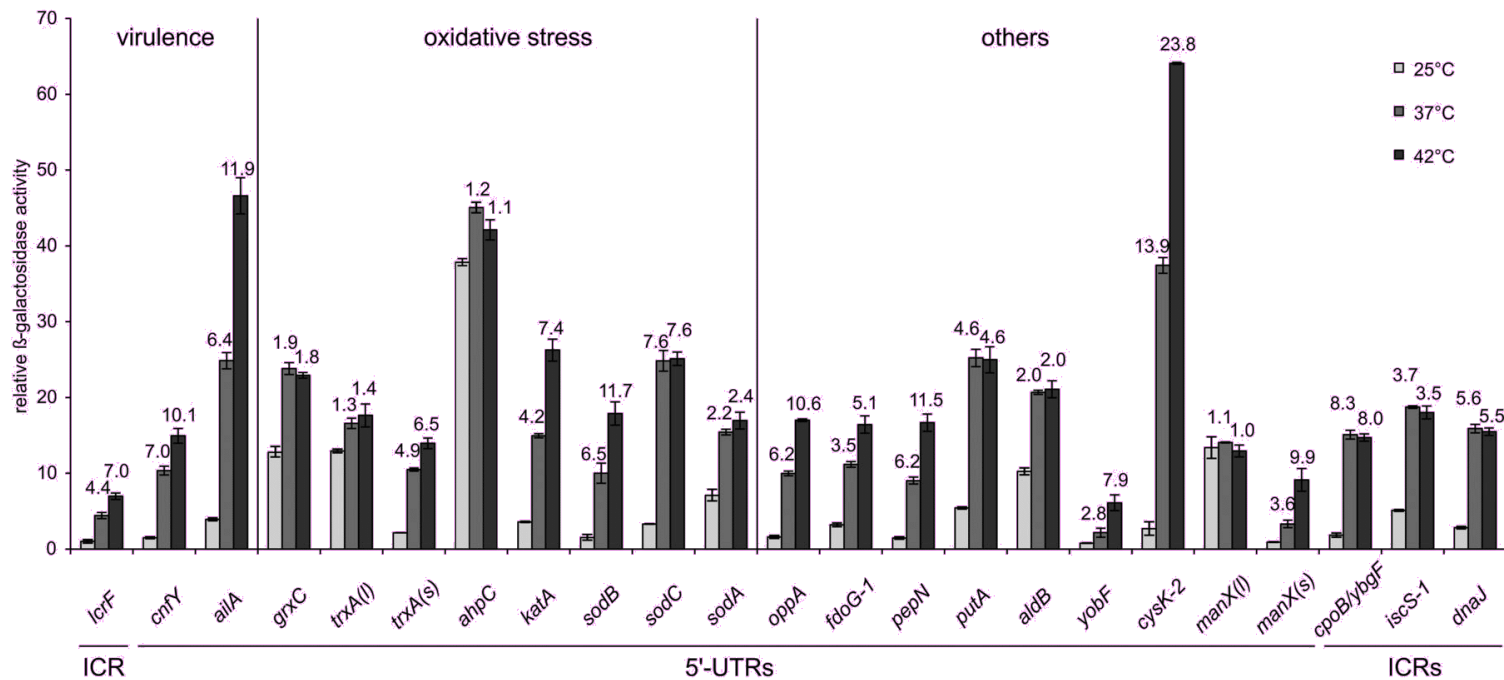

Righetti *et al.*, 2016

RNA Thermometers

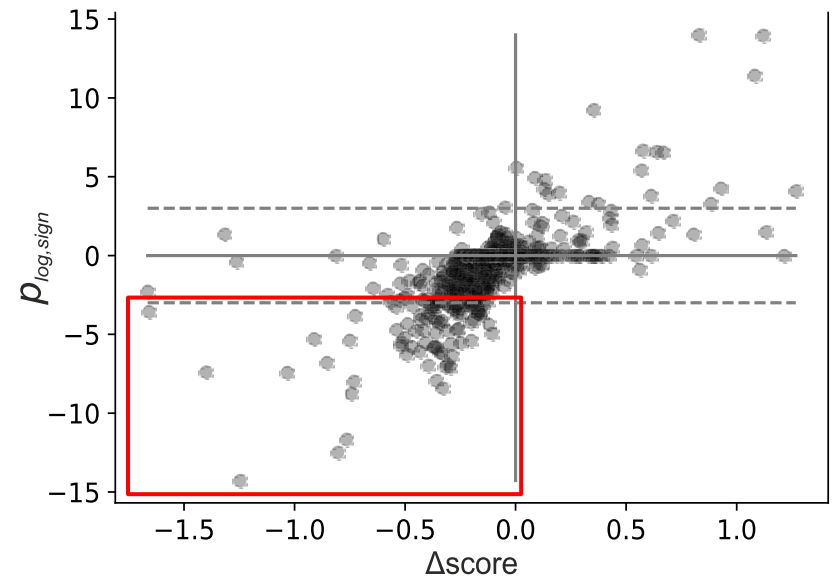
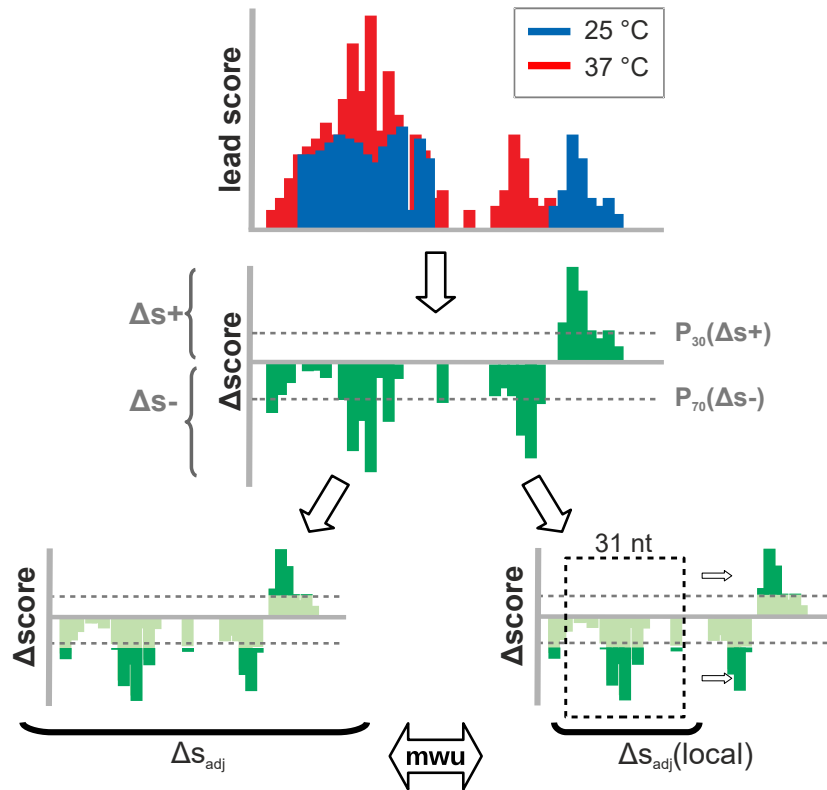
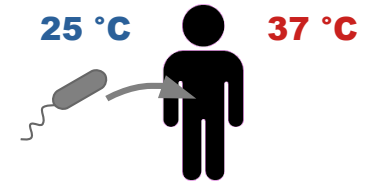

RNA thermometer

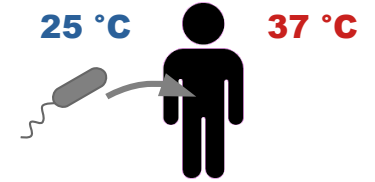

gene	gene description	Δ score	$p_{\log, \text{sign}}$
<i>ailA</i>	outer membrane protein	-1.4	-7.4
<i>pepN</i>	aminopeptidase	-0.5	-6.3
<i>sodB</i>	superoxide dismutase	-0.5	-4.8
<i>cysK-2</i>	cysteine synthetase	-0.3	-3.4
<i>trxA</i>	thioredoxin	-0.2	-3.2
<i>groES</i>	chaperonin	-1.7	-3.6
<i>clpB</i>	ATP-dependent chaperone	-0.5	-3.3

Righetti *et al.*, 2016

Brandenburg, unpublished

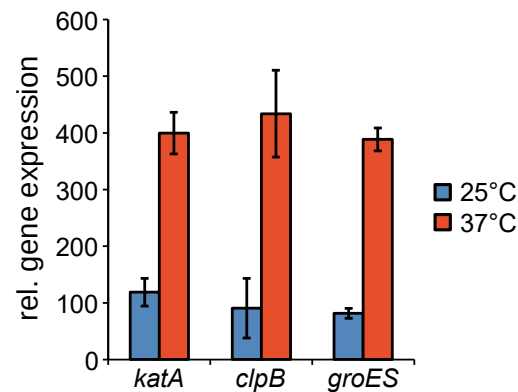
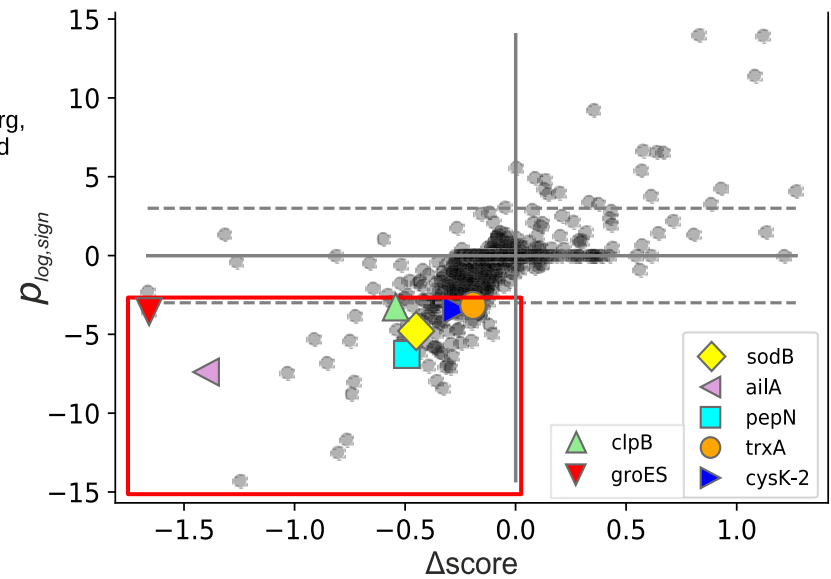

Summary

- Lead-Seq
 - Reliable information about tRNAs + larger molecules
 - Improve secondary structure predictions with soft constraints

- *Y. pseudotuberculosis*' structurome at 25 °C + 37 °C
 - General melting at higher temperature
 - 5'-UTRs more structured than CDS at 25 °C
 - Known + unknown RNA thermometers detectable

Microbial Biology, Ruhr-University Bochum

Prof. Dr. Franz Narberhaus

Dr. Christian Twittenhoff

Dr. Francesco Righetti

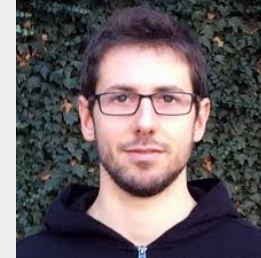

Bioinformatics, Ruhr-University Bochum

Prof. Dr. Axel Mosig



Molecular Infection Biology, HZI

Prof. Dr. Petra Dersch

Dr. Aaron M. Nuss

Thank you.
Questions?

Score calculation

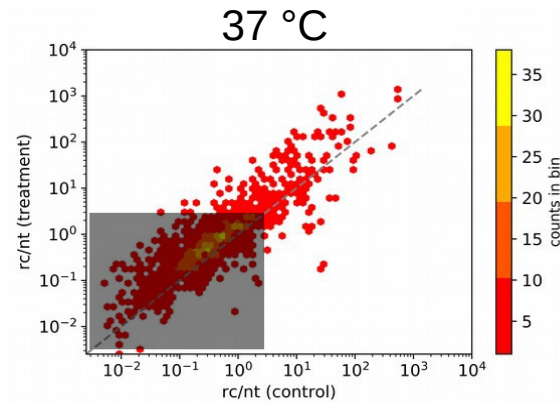
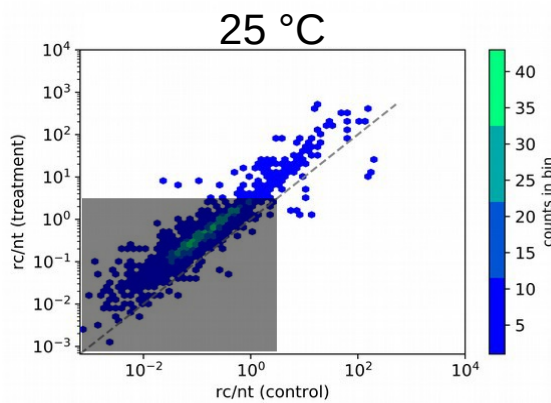

Avg. reads: 10005328 rc
 Transcriptome: 3009815 nt
 3.3 rc/nt

→ high signal-to-noise ratio at low-rawcount sites

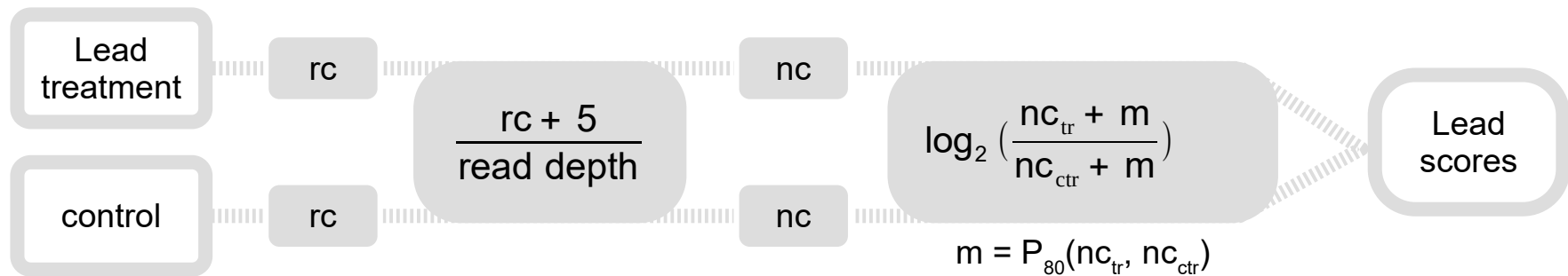

Library ID	Temperature	Treatment	Total number of read counts	Number of reads after trimming	Number of mapped reads t
BC_01	25 °C	control	10475715	9249830	529702
BC_02	25 °C	+lead(II) acetate	8853413	8441722	808248
BC_03	37 °C	control	17473908	15623283	815170
BC_04	37 °C	+lead(II) acetate	10069470	9952848	1093248

16S rRNA diff. to E.coli

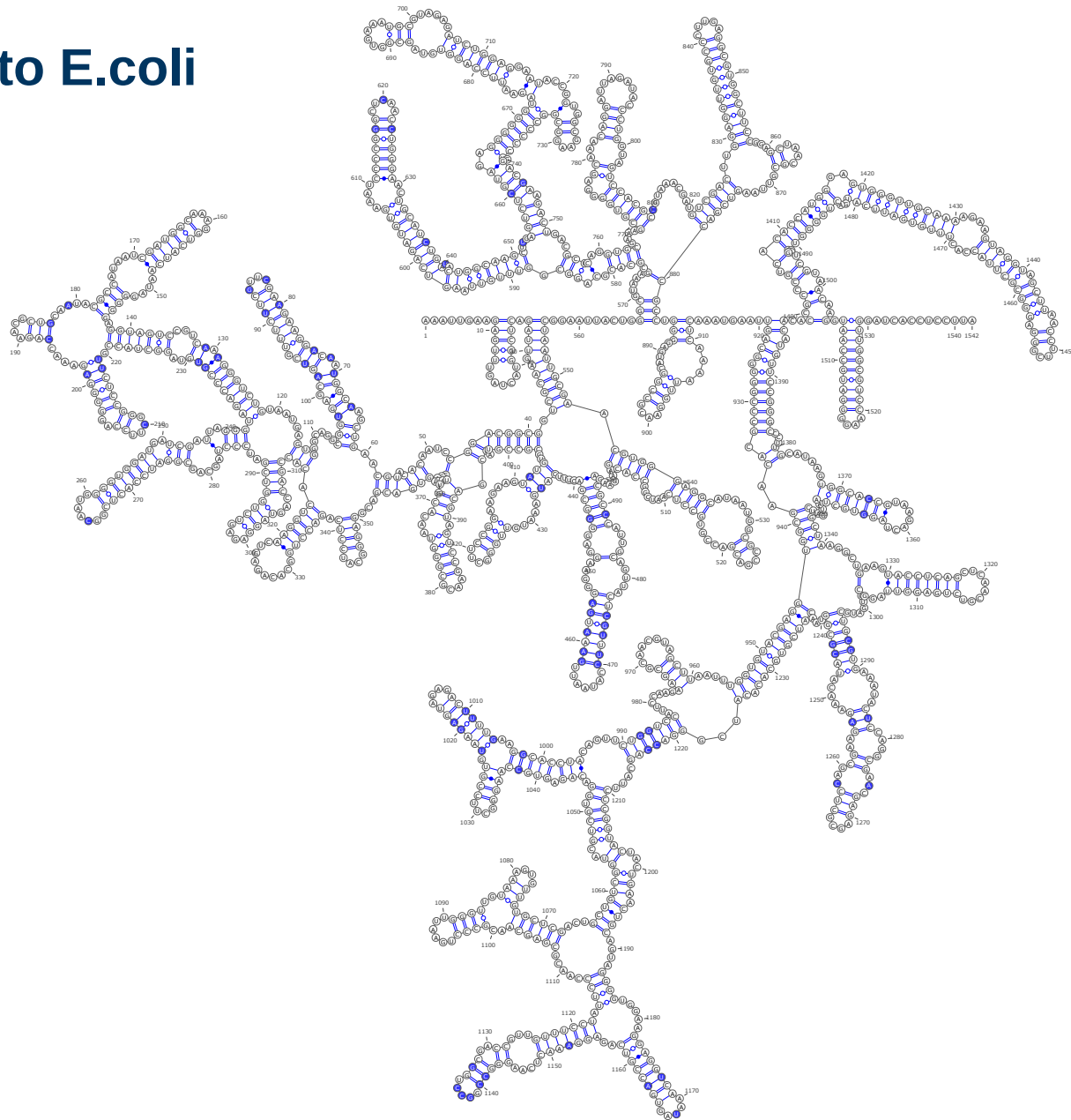

User file #6

